



Continental Retread Solutions

Retread Data Guide

Truck, Bus & Trailer Tires

Continental's worldwide, cutting edge life cycle solution.

A tailor-made program
that lowers cost and
prolongs the life of a tire.

The new standard in premium retreads - new tire technology,
new tire compounding & new tire tread designs.

**Providing fleets a complete tire life cycle with premium
Continental products.** Fleets rely on Continental new tires to deliver
the lowest overall driving cost. Now fleets can experience the superior
Continental performance through the entire life cycle of the casing.

Delivering your lowest overall driving cost. One of the largest automotive suppliers and tire manufacturers in the world, Continental develops pioneering technologies to make your fleet safer, more efficient, and more connected. With innovative tire technology and digital fleet solutions, Continental optimizes your tire management. Count on Continental to recommend the best tires and solutions for your specific fleet needs.

IMPORTANT NOTE:

Product details are subject to change. If the information you are looking for is not in this data guide, please visit www.continental-truck.com or contact your local sales representative for the most up to date information.

Table of Contents

OVERVIEW

Premium Retreads.....	04
ContiTread™ Product Overview	06
Retread Availability Chart	08
Retread Comparison Chart.....	10

RETREAD PRODUCT DATA

Long Haul Application Products.....	12
Regional Application Products.....	17
Urban Application Products.....	23
Construction Application Products.....	25
Off-Road Application Products.....	28

TABLES/CHARTS

Medium Truck Load/Inflation Tables.....	30
Load Limits at Various Speeds.....	34
Reading Tire Information.....	36
Definitions.....	39
Low Aspect Ratio Tires.....	40
Service Descriptions	41
Load Index Numbers.....	42
Tread Wear Conversion Table.....	43
Retread Casing Fitment Guide.....	44
Safety Warnings	45

CONTINENTAL HIGHLIGHTS

ContiLifeCycle™ Retread Stages	05	CLC-Soft	22
ContiLink	11	Janam XT2 Mobile Computer.....	24
EPA SmartWay	16	HorsePower Rewards Program.....	27

The new standard in premium retreads.

The long life of our Continental Truck Tires through the **ContiLifeCycle™** Process.

The life cycle of Continental Truck Tires

Continental Truck Tires are designed for ultimate economy over the entire life of the new tire and far beyond that when it comes to the casing.

The **ContiLifeCycle™** starts with the new tire and ends with the premium retread solution, **Continental Retread Solutions**.

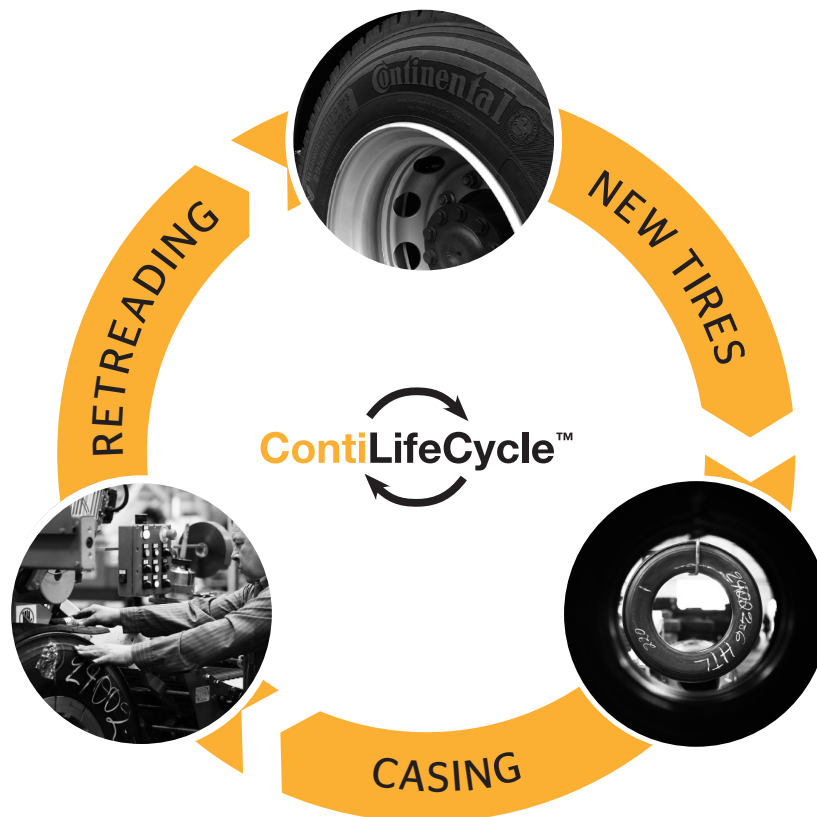

Continental Retread Solutions

ContiLifeCycle™ Retread Stages

Technology Driven for High-Quality Retreading

8 Process Control

Constant process and quality optimization by our globally connected retread specialists.

1 Inspection & Shearography

Thorough initial casing inspection using state-of-the-art technology.

2 Buffing

Precise buff contours and consistent under-tread thickness by computer controlled buffing.

7 Final Inspection

Detailed final inspection, ending with high pressure testing.

6 Curing

Ideal retread curing with precisely controlled time, temperature, vacuum and pressure.

3 Skiving & Repairs

Professional casing skiving and repairs, conducted by Continental trained operators.

5 Enveloping

Our modern enveloping technology enables an optimum curing process.

4 Tread Building

Optimum casing fitting, ensured by laser guided tread application.

To learn more, contact your Continental representative today!



ContiTread™

Product Overview

Legend:

	
SmartWay® Verified	New Tire Available

All-Position

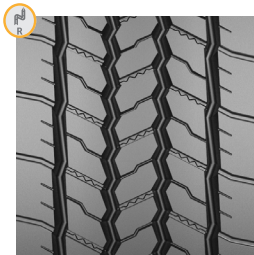

Conti HSR 5 (19.5")



HSR 3



HSR - 18/32"



HSR - 16/32"

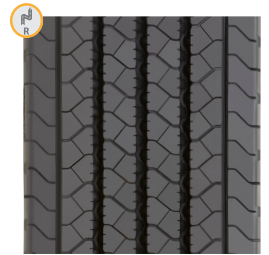

LSR1

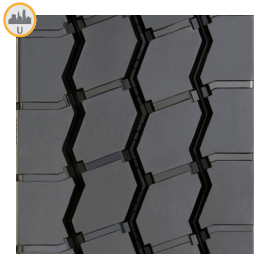

HAU 3 WT



HSC 3



HSC - 18/32"

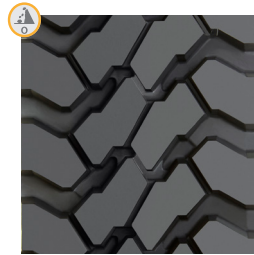

HCS

Drive Position

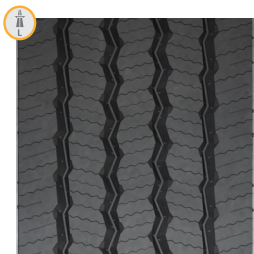

HDL 3 LTL-R



HDL2 DL

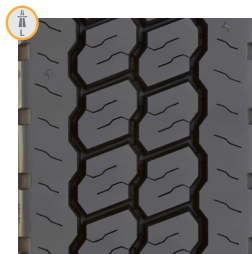

HDL



HDL Eco Plus



HDL2 Eco Plus

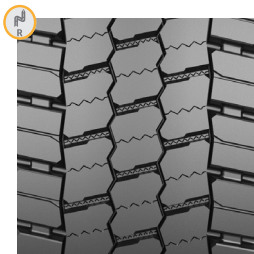

Conti HDR 5 (19.5")

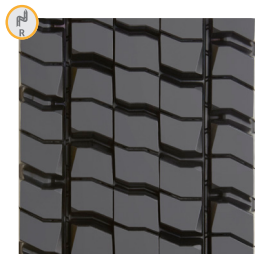

HDR2



HDR1

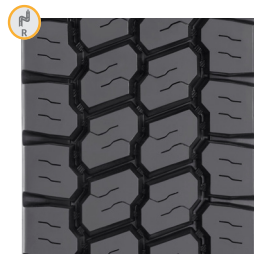

HDR1 Eco Plus

ContiTread™

Product Overview











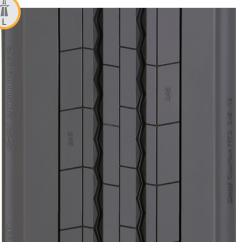

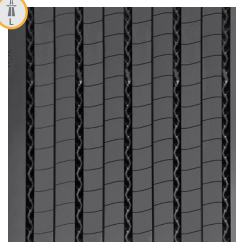







Legend:

	
SmartWay® Verified	New Tire Available

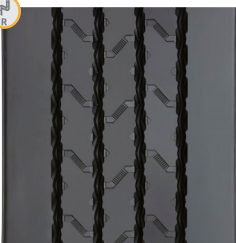
Drive Position (Continued)

				
Scandinavia HD3  	HDW2  	HDU 3 WT  	HDC 3  	HDC1 HT  

Trailer Position

				
EcoPlus HT3  	HTL  	HTL1  	Hybrid HT3  	HTR2 SA  
				
HTR2  	HTC1  			

ContiTread™ Retread Availability Chart

TREAD (MM)		160	170	180	185	188	190	195	200	205	210	215	220	225	230	235	240	
ALL-POSITION	HSR 5 (19.5")								16/32"		16/32"							
	HSR 3						20/32"		20/32"		20/32"		20/32"		20/32"		20/32"	
	HSR - 16/32"			16/32"				16/32"										
	HSR - 18/32"							18/32"				18/32"		18/32"		18/32"		
	LSR1	15/32"		15/32"		15/32"		15/32"		15/32"								
	HAU 3 WT										26/32"		26/32"		26/32"		26/32"	
	HSC 3										24/32"		24/32"		24/32"		24/32"	
	HSC											18/32"		18/32"		18/32"		
	HCS											32/32"		32/32"		32/32"		
DRIVE POSITION	HDL 3 LTL-R										22/32"		22/32"		22/32"		22/32"	
	HDL2 DL											28/32"		28/32"		28/32"		
	HDL - 13/32"											13/32"		13/32"		13/32"		
	HDL - 20/32"											20/32"		20/32"		20/32"		
	HDL - 26/32"											26/32"		26/32"		26/32"		
	HDL Eco Plus - 20/32"											20/32"		20/32"		20/32"		
	HDL Eco Plus - 26/32"											26/32"		26/32"		26/32"		
	HDL2 Eco Plus																	
	HDR 5 (19.5")								22/32"		22/32"		22/32"					
	HDR2 - 22/32"				22/32"				22/32"									
	HDR2 - 26/32"									26/32"		26/32"		26/32"		26/32"		26/32"
	HDR1 - 16/32"	16/32"	16/32"	16/32"				16/32"		16/32"		16/32"						
	HDR1 - 20/32"							20/32"		20/32"								
	HDR1 - 22/32"																22/32"	
	HDR1 - 26/32"												26/32"		26/32"		26/32"	
	HDR1 Eco Plus											22/32"		22/32"		22/32"		
	Scandinavia HD3											25/32"		25/32"		25/32"		25/32"
	HDW2												27/32"		27/32"		27/32"	
	HDU 3 WT											32/32"		32/32"		32/32"		32/32"
	HDC 3											28/32"		28/32"		28/32"		28/32"
HDC1 HT														32/32"		32/32"		
TRAILER POSITION	EcoPlus HT3											13/32"		13/32"		13/32"		
	HTL								13/32"		13/32"		13/32"		13/32"		13/32"	
	HTL1																	
	Hybrid HT3								16/32"		16/32"		16/32"		16/32"			
	HTR2 SA																16/32"	
	HTR2																	
HTC1																		

ContiTread™

Retread Availability Chart (Continued)

TREAD (MM)		245	250	255	260	270	280	290	320	340	350	360	370	380	390	400	410
ALL-POSITION	HSR 5 (19.5")																
	HSR 3																
	HSR - 16/32"																
	HSR - 18/32"	18/32"			18/32"												
	LSR1																
	HAU 3 WT		26/32"		26/32"	26/32"	26/32"										
	HSC 3																
	HSC																
	HCS	32/32"											32/32"		32/32"		
DRIVE POSITION	HDL 3 LTL-R																
	HDL2 DL	28/32"															
	HDL - 13/32"																
	HDL - 20/32"																
	HDL - 26/32"	26/32"															
	HDL Eco Plus - 20/32"	20/32"															
	HDL Eco Plus - 26/32"	26/32"															
	HDL2 Eco Plus														24/32"	24/32"	
	HDR 5 (19.5")																
	HDR2 - 22/32"																
	HDR2 - 26/32"	26/32"															
	HDR1 - 16/32"																
	HDR1 - 20/32"																
	HDR1 - 22/32"																
	HDR1 - 26/32"	26/32"															
	HDR1 Eco Plus																
	Scandinavia HD3																
	HDW2	27/32"			27/32"												
	HDU 3 WT		32/32"		32/32"	32/32"	32/32"										
	HDC 3		28/32"														
HDC1 HT	32/32"																
TRAILER POSITION	EcoPlus HT3	13/32"															
	HTL																
	HTL1														13/32"	13/32"	
	Hybrid HT3																
	HTR2 SA		16/32"		16/32"	16/32"											
	HTR2								22/32"	22/32"	22/32"						
HTC1									24/32"		24/32"			23/32"			

ContiTread™

Retread Comparison Chart

	ContiTread™	BANDAG	MICHELIN	GOODYEAR
ALL-POSITION	HSR 5 - 19.5"	BDR-AS	XDE M/S, XDC	G167
	HSR 3	UAP2, BDV	XZE2	G661 HSA
	HSR - 18	Ultra All Position	XZE	All Position 18, G661 HSA
	HSR - 16	FCR Rib	XZE	G159, G661 HSA
	LSR1	FCR Rib	XZA	G159
	HAU 3 WT	BRM, BRM3	XZUS	Endurance WHA, G686 G289 WHA
	HSC 3	BRM, BRX2	XZY3	G287 MSA
	HSC	BRX	XZY	G186 MSA
	HCS	BDY2	XZL, XZH	G177 Modified
DRIVE POSITION	HDL 3 LTL-R	B713, B760	X Multi Energy D	-
	HDL2 DL	MegaTrek	XDA HT	G328
	HDL - 26	Ultra Drive	XDHT	G362
	HDL - 20	FCR Drive, DR 5.3	XDHT	G362
	HDL - 13	BTT2	XDC LL	G362
	HDL Eco Plus - 26	B710 Fuel Tech	X Line Energy D	G572 LHD Fuel Max
	HDL Eco Plus - 20	FCR Drive	XDA 2 AT	Fuel Max LHD G505D
	HDL2 Eco Plus	B835 FuelTech	X One Line Energy D	G392 SSD Fuel Max
	HDR 5 - 19.5"	FCR Rib	XZA	G647 RSA
	HDR2 - 22	BDR-AS	MD XDN2	G167
	HDR2 - 26	Ultra Drive, BDR-HT3	X Multi D, XD4, XDN2	G182
	HDR1 - 16	BDLT	XDE M/S	G622 LT
	HDR1 - 20	BDL	XDE M/S	RDA
	HDR1 - 22	BDR-AS	XDE M/S, XDC	G167
	HDR1 - 26	Ultra Drive	XDN2	G338
	HDR1 Eco Plus	BDR-AS	-	G622
	Scandinavia HD3	-	XDS2	Endurance WTD, WinterTrac 2
	HDW2	BDR-W	XDS2	G622 RSD
	HDU 3 WT	BDM3	XDUS	Endurance WHD, G292 WHD
	HDC 3	BDY2, BDY1	XDY, XDY-1	G677 MSD
	HDC1 HT	BDY2	XDY-EX	G741 MSD
TRAILER POSITION	Conti EcoPlus HT3	B123, B197 FuelTech, FCR T2	XTA-2, X Line Energy T, XT-1 AT	G316 AT Fuel Max
	HTL	BTL, TR 4.1	XTA-1	G314, G159, LCT 11
	HTL1	B135 FuelTech	X One Line Energy T & T2	G394 SST Fuel Max
	Hybrid HT3	B123, B197 Fuel Tech, FCR T2	X Multi T SA, XTY SA	G619 RST
	HTR2 SA	BTL-SA, ECL ST	XTE2 Widebase, XTA	G619 RST
	HTR2	-	XZH, XZA Wide Base	G296 MSA
	HTC1	BRM-WB	XZL, XZY3 and XZY Widebase	G296 MSA

ContiLink

Your Connection to Dealer Support & Resources

Standard Claims Processing

If you can name it, you can claim it... pricing, shipping, sales tax, advertising and waste fee claims are just a few that have the ability to process through ContiLink.

Order Tracking

Whether you need to check product availability, place an order, track shipping or monitor backorder reports, ContiLink has your needs covered.

Marketing Needs

As a Continental dealer, you can purchase sales literature and point-of-sale material for your showroom anytime, or download digital copies in PDF format. Simply log into ContiLink and click on the Marketing Suite banner.

National Accounts & Government Claims

Through the National Accounts and Government Claims section of ContiLink, you can submit delivery receipts, review customer requirements, submit government claims and more.

Financial

Through ContiLink's Financial feature, you have the ability to view real-time debits/credits on open items and print, email or save copies of invoices, statements and credit memos.

Emergency Road Service Tracking

With detailed reporting from Continental's TrukFix emergency road service program, you can see at a glance your acceptance rates for calls and opportunities to increase service revenue with Continental.

ContiACADEMY

Gain access to ContiAcademy, our virtual training platform to learn about Continental products, solutions, and live training opportunities.

LOG ON TO WWW.CONTILINK.COM TODAY!

Administration

ContiLink gives Dealers the flexibility to update their profiles. Keep your dealer location information up to date, and edit users and user information as needed.

Digital Downloads

Need instant access to Continental resources? Visit the Marketing section of the ContiLink site and download digital copies of the literature you need, including your Dealer Marketing Program book.

Live Chat

Chat with a Truck Tires Inside Sales representative or a National Account specialist to check your orders or if you have a question about a delivery receipt. Get the information you need when you need it.

ContiTread™



Long Haul

Retread Product Overview

For Long Distance Highway Driving

Legend:



HDL 3 LTL-R
 



HDL2 DL
 



HDL
 



HDL Eco Plus
 



HDL2 Eco Plus
 



EcoPlus HT3
 



HTL
 

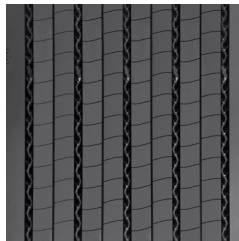

HTL1
 



ContiTread HDL 3 LTL-R | Long Haul, Single Axle Drive



PRODUCT DATA				<ul style="list-style-type: none"> • Maximum fuel efficiency and high removal miles from advanced tread compounding. • Resists irregular wear caused from high-torque single drive position, including heel-toe wear, thanks to rigid tread blocks that effectively control movement. • 3-D matrix sipes provide superior traction and even wear. • Maximum stone ejection due to superior groove geometry.
WIDTH (MM)	ARTICLE NUMBER	TREAD DEPTH (32nds)		
210	18215140000	22		
220	18215150000	22		
230	18215160000	22		
240	18215170000	22		

ContiTread HDL2 DL | Long Haul Drive, Deep Lug



PRODUCT DATA				<ul style="list-style-type: none"> • Optimized compound with ultra deep tread delivers high mileage. • Minimized wear and excellent traction over the life of the tire through a wide, closed shoulder tread and numerous tread blocks with multiple grip edges. • Patented innovative groove technology leads to minimum stone retention, extending casing life.
WIDTH (MM)	ARTICLE NUMBER	TREAD DEPTH (32nds)		
215	18217680000	28		
225	18217690000	28		
235	18217700000	28		
245	18217710000	28		

ContiTread HDL | Long Haul Drive



PRODUCT DATA				<ul style="list-style-type: none"> • Cut and tear resistant tread compound for excellent wear. • Closed shoulder tread design provides even tread wear while still providing excellent traction. • Patented innovative groove technology leads to minimum stone retention, extending casing life.
WIDTH (MM)	ARTICLE NUMBER	TREAD DEPTH (32nds)		
215	18217730000	26		
225	18217740000	26		
235	18217750000	26		
245	18217760000	26		
215	18217770000	20		
225	18217780000	20		
235	18217790000	20		
215	18217820000	13		
225	18217830000	13		
235	18217840000	13		



Legend:





SmartWay® Verified New Tire Available



ContiTread HDL Eco Plus | Fuel-Efficient, Long Haul Drive

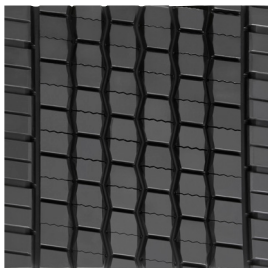

PRODUCT DATA			 
WIDTH (MM)	ARTICLE NUMBER	TREAD DEPTH (32nds)	
215	18204820000	26	<ul style="list-style-type: none"> Advanced, fuel-efficient compound provides long original mileage and rolling resistance. Closed shoulder tread design provides even tread wear while still providing excellent traction. Patented innovative groove technology leads to minimum stone retention, extending casing life.
225	18204830000	26	
235	18204840000	26	
245	18204850000	26	
215	18204860000	20	
225	18204870000	20	
235	18204880000	20	
245	18204890000	20	



ContiTread HDL2 Eco Plus | Fuel-Efficient, Super Single Drive



PRODUCT DATA			 
WIDTH (MM)	ARTICLE NUMBER	TREAD DEPTH (32nds)	
390	18209240000	24	<ul style="list-style-type: none"> Super single drive tire with advanced compounding for low rolling resistance and high mileage.
400	18206780000	24	

ContiTread EcoPlus HT3 | Fuel-Efficient, Long Haul Trailer



PRODUCT DATA			 
WIDTH (MM)	ARTICLE NUMBER	TREAD DEPTH (32nds)	
215	18208620000	13	<ul style="list-style-type: none"> Ultra low rolling resistant compounding. Optimized tread pattern resists irregular wear. 13/32nd tread depth for high removal mileage. Fuel Saving Edge technology available in 245mm tread width for maximum fuel efficiency.*
225	18208630000	13	
235	18208640000	13	
245*	18208650000	13	

Legend:



ContiTread HTL | Long Haul Trailer



PRODUCT DATA		
WIDTH (MM)	ARTICLE NUMBER	TREAD DEPTH (32nds)
200	18208720000	13
210	18205420000	13
220	18205440000	13
230	18205460000	13
240	18206800000	13

- 13/32" tread depth minimizes tread squirm and irregular wear.
- Patented innovative groove technology leads to minimum stone retention, extending casing life.

ContiTread HTL1 | Fuel-Efficient, Super Single Trailer

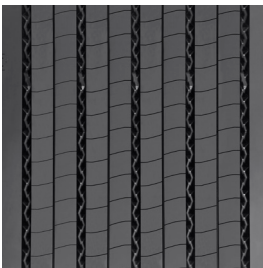

PRODUCT DATA		
WIDTH (MM)	ARTICLE NUMBER	TREAD DEPTH (32nds)
390	18214670000	13
400	18214680000	13

- Optimized compound for regional and long hauling delivers high mileage.
- Proven 13/32" tread design.
- New solid shoulder design for durability.
- Patented innovative groove technology leads to minimum stone retention, extending casing life.

EPA SmartWay®

Reducing Transportation-Related Emissions and Improving Supply Chain Fuel Efficiency

Verified Low-Rolling Resistance Tire Products

The EPA has determined that certain tire product models and technologies can reduce NOx emissions and fuel use by 3 percent or more, relative to the best-selling products for line haul class 8 tractor trailers. These improvements are achieved under the following conditions:

- Tires are used in the correct axle positions.
- Verified low rolling resistance tires are installed on all of the axle positions of the tractor and trailer.
- All tires must be properly inflated according to the manufacturer's specifications.

For more information on SmartWay or to review the list of SmartWay verified low rolling resistance tires and retread technologies, visit www.epa.gov/smartway.



Fuel Savings



Cleaner Air



Cost Savings



Environmentally Friendly

The following Continental low-rolling resistance retread products are SmartWay verified when used on class 8, line-haul tractor trailers:

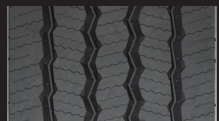

HDL 3 LTL-R

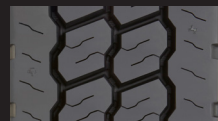

HDL Eco Plus

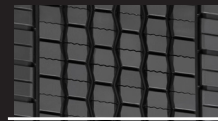

HDL2 Eco Plus

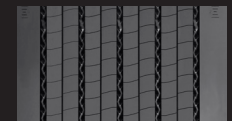

HTL1

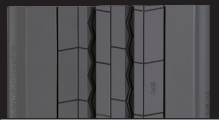

EcoPlus HT3



Regional Retread Product Overview

For Highway & Local Driving

Legend:

SmartWay® Verified	New Tire Available

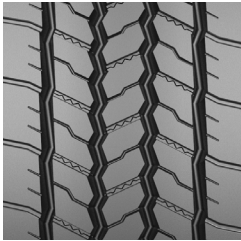

HSR 5 (19.5")



HSR 3

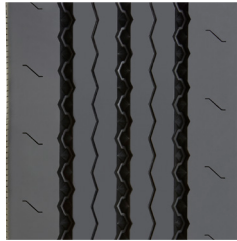

HSR - 18/32"



HSR - 16/32"

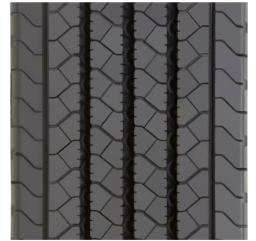

LSR1

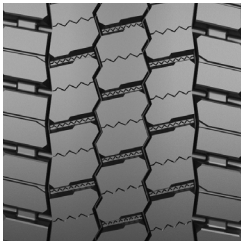

HDR 5 (19.5")



HDR2



HDR1



HDR1 Eco Plus



Scandinavia HD3



HDW2



Hybrid HT3



HTR2 SA



HTR2

Legend:



SmartWay® Verified New Tire Available

ContiTread HSR 3 | Regional All-Position



PRODUCT DATA		
WIDTH (MM)	ARTICLE NUMBER	TREAD DEPTH (32nds)
190	18217850000	20
200	18217860000	20
210	18217870000	20
220	18217880000	20
230	18217890000	20
240	18217900000	20

- Zigzag center groove geometry increases the number of biting edges for increased traction.
- Pyramidal stone ejectors in all tread grooves to stop stone retention for long casing life.
- Durable compounding for mileage.

ContiTread HSR - 16/32" | 19.5" Regional All-Position



PRODUCT DATA		
WIDTH (MM)	ARTICLE NUMBER	TREAD DEPTH (32nds)
180	18310030000	16
195	18310460000	16

- 16/32" cut and chip resistant tread for long tread life.
- Aggressive tread design provides excellent lateral stability to minimize squirm, and improve wet handling performance.
- Closed shoulder to protect against curbing, cuts and abrasions.

ContiTread HSR - 18/32" | Regional All-Position



PRODUCT DATA		
WIDTH (MM)	ARTICLE NUMBER	TREAD DEPTH (32nds)
195	18207940000	18
215	18204780000	18
225	18204790000	18
235	18204800000	18
245	18204810000	18
260	18310610000	18

- Cut and chip resistant tread for long tread life.
- Pyramidal stone ejectors in all tread grooves to stop stone retention for long casing life.
- Robust shoulder rib for long tread life.

ContiTread HSR 5 | 19.5" Regional Steer Position



PRODUCT DATA		
WIDTH (MM)	ARTICLE NUMBER	TREAD DEPTH (32nds)
200	18219600000	16
210	18219610000	16

- Tread compound designed to provide longer life in regional applications.
- Tread pattern and siping provides excellent wet/dry traction, and resists irregular wear.
- Narrow width for 19.5" casings.

Legend:



ContiTread LSR1 | 17.5" Regional All-Position

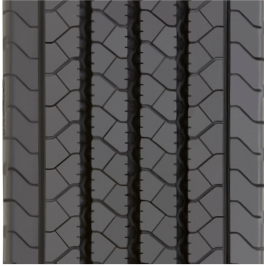

PRODUCT DATA		
WIDTH (MM)	ARTICLE NUMBER	TREAD DEPTH (32nds)
160	18206070000	15
180	18206080000	15
188	18206090000	15
195	18206100000	15
205	18207890000	15

- Advanced tread compound provides high mileage in regional applications.
- Multi-rib tread design features excellent wet traction, lateral stability and reduced noise.
- Unique pyramid shaped stone ejection system in all tread grooves reduce stone retention and casing penetrations.

ContiTread HDR2 | Regional Drive



PRODUCT DATA		
WIDTH (MM)	ARTICLE NUMBER	TREAD DEPTH (32nds)
185	18215760000	22
195	18215770000	22
205	18215780000	22
215	18215790000	22
225	18215800000	22
235	18215810000	22
245	182157820000	22

- Cut and tear resistance tread compound for excellent wear in regional and light On/Off applications.
- Optimal performance on various road conditions, through an innovative tread compound.
- Unidirectional, arrow shaped tread pattern minimizes typical drive tire wear effects.

ContiTread HDR 5 | 19.5" Regional Drive

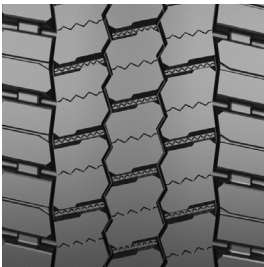

PRODUCT DATA		
WIDTH (MM)	ARTICLE NUMBER	TREAD DEPTH (32nds)
200	18219620000	22
210	18219630000	22
220	18219640000	22

- Cut and tear resistant tread compound for excellent wear in regional applications.
- Open shoulder tread design along with advanced siping provides excellent wet/dry traction, and resists irregular wear.
- Narrow width for 19.5 casings.

Legend:



SmartWay® Verified New Tire Available

ContiTread HDR1 | Regional Drive



PRODUCT DATA		
WIDTH (MM)	ARTICLE NUMBER	TREAD DEPTH (32nds)
160	18215600000	16
170	18215610000	16
180	18215620000	16
190	18215630000	16
200	18215640000	16
215	18215650000	16
190	18215660000	20
200	18215670000	20
235	18215700000	22
215	18215720000	26
225	18215730000	26
235	18215740000	26
245	18215750000	26

- Cut and tear resistant tread compound for excellent wear in regional and light On/Off applications.
- Open shoulder tread design provides excellent wet/dry traction, resists irregular wear and reduces stone retention.
- Innovative lug angle provides outstanding traction throughout the life of the tread.

ContiTread HDR1 Eco Plus | Regional Drive



PRODUCT DATA		
WIDTH (MM)	ARTICLE NUMBER	TREAD DEPTH (32nds)
215	18207700000	22
225	18207710000	22
235	18207720000	22

- Advanced, fuel efficient compound provides long original mileage and rolling resistance.
- Open shoulder tread design provides excellent wet/dry traction, resists irregular wear and reduces stone retention.
- Innovative lug angle provides outstanding traction throughout the life of the tread.

ContiTread Scandinavia HD3 Regional Drive for Extreme Weather Conditions



PRODUCT DATA		
WIDTH (MM)	ARTICLE NUMBER	TREAD DEPTH (32nds)
210	18211340000	25
220	18211350000	25
230	18211360000	25
240	18211370000	25

- Directional* tread pattern for improved traction.
- Full sipes located on center ribs in center grooves at 22/32" for improved snow evacuation.
- Pocket sipes featured throughout the tread pattern at 13/32"
- Optimized groove geometry for stone trapping resistance.
- Tie bars included to improve wear mileage near end of life.

Legend:



ContiTread HDW2 | Regional Drive for Extreme Weather Conditions



Tread B

PRODUCT DATA		
WIDTH (MM)	ARTICLE NUMBER	TREAD DEPTH (32nds)
215	18209370000	27
225	18209380000	27
235	18209390000	27
245 (Tread B)	18209400000	27
260 (Tread B)	18209410000	27

- High-mileage compound
- All season tread ensures optimum performance in a variety of winter conditions from ice to snow.
- Directional* tread design with more than 1,000 sipes provides excellent traction and lateral stability in 245 and 260 mm sizes.

ContiTread Hybrid HT3 | Regional Trailer for Spread-Axle



PRODUCT DATA		
WIDTH (MM)	ARTICLE NUMBER	TREAD DEPTH (32nds)
200	18214620000	16
210	18214630000	16
220	18214640000	16
230	18214650000	16

- New and improved winged tread for use in high scrub applications, particularly spread-axle and multi-axle.
- Durable high mileage compounding.
- Pyramidal stone ejection system integrated into the center groove for added casing protection.

ContiTread HTR2 SA | Regional Trailer for Spread-Axle



PRODUCT DATA		
WIDTH (MM)	ARTICLE NUMBER	TREAD DEPTH (32nds)
240	18207560000	16
250	18207570000	16
260	18207580000	16
270	18207590000	16
290	18207600000	16

- Winged tread for use in high scrub applications, particularly spread-axle and multi-axle.
- High mileage achieved through precise balance of tread compound and geometry.

ContiTread HTR2 | Regional Trailer



PRODUCT DATA		
WIDTH (MM)	ARTICLE NUMBER	TREAD DEPTH (32nds)
290	18206730000	22
320	18206740000	22
340	18206750000	22

- High mileage achieved through precise balance of tread compound and geometry.
- Tread pattern designed for increased stability and reduced noise.
- Patented innovative groove technology leads to minimum stone retention.

CLC-Soft

Continental's Web Software for Automating the ContiLifeCycle™ Process

- 1 Inspection & Shearography**
Scan tire to display detailed information about the tire and begin the process to enter all found injuries.
- 2 Buffing**
Pass tread and sizing information to buffing machine for precise and controlled buffing.
- 3 Skiving & Repairs**
Add all patch repairs applied to fix injuries previously identified.
- 4 Tread Building**
Select and scan tread roll to apply to tire casing. Data is transferred to backoffice to track inventory.
- 5 Enveloping**
Couple tire with envelope to track progress in and out of curing chamber.
- 6 Curing**
Scan envelope to record contents of curing chamber and help set curing instructions.
- 7 Final Inspection**
Pass/Reject tire after thorough inspection of all listed injuries and repairs.
- 8 Process Control**
Constant process and quality optimization by our globally connected retread specialists.



WWW.CLCSOFT.COM - YOUR CONTILIFECYCLE SOLUTION

Automization

CLC-Soft is designed to make your business more efficient and reduce the chance of errors from manual input. CLC-Soft's ability to interface with other backoffice financial products provides automation from the shop floor to your Accounting Department.

Accessibility

As a cloud based web system, CLC-Soft makes your data accessible from anywhere in the world as long as you have an internet connection. With easy installation and minimal hardware investments, CLC-Soft will print labels, work with barcode scanners and on touch screens.

Reporting

CLC-Soft offers both Administrative and Sales Reports, i.e. Raw Material in Process, Reworks & Reruns, Number of Tires Processed, and Reject Rates. Tire information is printed on quality labels, which is applied to every tire in your shop.



Urban Retread Product Overview

For Inner City Traffic & Short Distances

Legend:

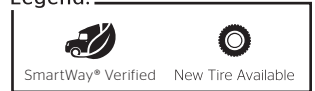

ContiTread HAU 3 WT | Urban All-Position for Waste Transport



PRODUCT DATA		
WIDTH (MM)	ARTICLE NUMBER	TREAD DEPTH (32nds)
210	18217910000	26
220	18217920000	26
230	18217930000	26
240	18217940000	26
250	18217950000	26
260	18217960000	26
270	18217970000	26
280	18217980000	26

- Optimized tread compound for long removal mileage and chip and chunk resistance.
- Robust four rib tread design for increased durability in high scrub applications.
- Zig-zag groove geometry engineered specifically for use in waste transportation.

ContiTread HDU 3 WT | Urban Drive for Waste Transport



PRODUCT DATA		
WIDTH (MM)	ARTICLE NUMBER	TREAD DEPTH (32nds)
210	18217990000	32
220	18218000000	32
230	18218010000	32
240	18218020000	32
250	18218030000	32
260	18218040000	32
270	18218050000	32
280	18218060000	32

- Deep 32/32" tread depth and open shoulder tread design for excellent traction.
- Shoulder notches included in design to prevent heat build-up.
- Chip and chunk resistant compounding for endurance in waste and other high scrub applications.
- Tie bars included to improve wear mileage near end of life.

Janam XT2 Mobile Computer Integrated with CLC-Soft

Real-Time Data for Better Service

Increasing efficiency + improving customer service is a win-win. Our ContiLifeCycle partners can now access the latest technology, enabling them to deliver the best service while minimizing human error.

With the Janam XT2 mobile computer, any employee can:

- Stay connected to CLC-Soft, no matter where the job takes them
- Track tires in real-time via barcodes
- Capture rejected tires at customer site and enter tires into CLC-Soft
- Run real-time reports while on-site at a customer location
- Upload information without needing to dock the device
- Send Work Orders to customers via e-mail (no more paper!)



Supplied by RMS Omega: Call 888-857-8402 for purchasing information

This device is not supplied by Continental but is approved for use with Continental software

Monitor and maximize your ContiLifeCycle process with a mobile computer integrated with CLC-Soft

ContiLifeCycle™ Process

Keep track of tires during every step of the ContiLifeCycle process. Barcodes on tires and at each operating station allow for accurate tracking and process control throughout the process.

CLC-Soft Reporting

CLC-Soft allows you to have your finger on the pulse of your retread operation, along with helping you increase productivity. Tire information is printed on quality labels, helping eliminate human error.

CLC Mobile Computer

Tested against other leading products, the Janam XT2 Mobile Computer stands out for its freedom from a docking system to upload data, ability to run real-time data, and rugged, lightweight, portable nature.



Construction

Retread Product Overview

Legend:

SmartWay® Verified	New Tire Available

For Durability On & Off-Road



HSC 3
 



HSC - 18/32"
 



HDC 3
 



HTC1
 

Legend:



SmartWay® Verified New Tire Available

ContiTread HSC 3 | Construction Steer/All-Position



PRODUCT DATA		
WIDTH (MM)	ARTICLE NUMBER	TREAD DEPTH (32nds)
210	18215050000	24
220	18215060000	24
230	18215070000	24
240	18215080000	24

- Enhanced compound for improved mileage and chip and chunk resistance.
- Groove geometry reduces stone retention for enhanced retreadability.
- Rounded closed shoulder design to improve wear and optimize durability in multi-axle positions.

ContiTread HSC | Construction All-Position



PRODUCT DATA		
WIDTH (MM)	ARTICLE NUMBER	TREAD DEPTH (32nds)
215	18205480000	18
225	18205490000	18
235	18205500000	18

- On/Off-road compound increases resistance to cuts, chips and chunks. Also, reduces the number and depth of any cuts and tears.
- Patented innovative groove technology leads to minimum stone retention, extending casing life.

ContiTread HDC 3 | Construction Drive



PRODUCT DATA		
WIDTH (MM)	ARTICLE NUMBER	TREAD DEPTH (32nds)
210	18215090000	28
220	18215100000	28
230	18215110000	28
240	18215120000	28
250	18215130000	28

- Diamond shaped lugs and optimal void volume for excellent traction.
- Open shoulder tread design for use in mud, gravel and dirt.
- Enhanced compound for improved mileage and chip and chunk resistance.
- Self-cleaning tread pattern and miniature stone bumpers reduce stone retention for enhanced retreadability.

ContiTread HTC1 | Construction Trailer



PRODUCT DATA		
WIDTH (MM)	ARTICLE NUMBER	TREAD DEPTH (32nds)
320	18206760000	24
350	18206770000	24
380	18219490000	23

- Aggressive multi-surface, all-position tread pattern provides excellent traction.
- Outstanding self-cleaning properties ensure a long service life.

CONSTRUCTION



HorsePower UnTamed

Continental's Loyalty Rewards Program

HORSEPOWER

untamed

horsepowerrewards.com

Enroll Today! Contact your Continental representative to learn more.



Some Sweet Rewards For You

Sell tires. Collect points. Earn rewards. Repeat. Choose from an extensive collection of name-brand apparel, cash gift cards and more.



We Value Your Loyalty

Sell a certain number of tires and you will receive a gift and a recognition plaque. We appreciate your loyalty and now allow us to return the favor.



Earning Points is Easy

Once enrolled, you'll have 45 days from the end of the month to submit tire sales. Simply login and use the Power Page to upload invoices and submit claims. Points will be instantly deposited into your account upon claim approval.

HorsePower Untamed is available by invitation only to a select group of individual salespeople selling to fleets and users directly. No wholesale or intercompany transfers are permitted in this program. No sales may be aggregated; but must be solely the reporting participant's sales. Any tax liability is the individual's responsibility. A valid individual W-9 tax form including your SSN (not a company tax ID) must be on file with Continental to redeem in the program. As well as TD1 form for Canadian participants. Aggregation of points over groups of salesman and/or tax information that is of a business nature will not be permitted. Owners and dealer principals are not eligible to participate in this program.



ContiTread™

Off-Road Retread Product Overview

For Severe Service & Maximum Durability

Legend:

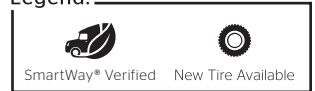

ContiTread HCS | Severe Service All-Position



PRODUCT DATA		
WIDTH (MM)	ARTICLE NUMBER	TREAD DEPTH (32nds)
215	18213510000	32
225	18213520000	32
235	18213530000	32
245	18213540000	32
360	18213550000	32
380	18213560000	32

- Cut and tear resistant tread compound for long tread life in On/Off road conditions.
- Outstanding self-cleaning properties ensure a long service life.
- Aggressive tread pattern provides excellent traction.

ContiTread HDC1 HT | Construction Drive for High Traction



PRODUCT DATA		
WIDTH (MM)	ARTICLE NUMBER	TREAD DEPTH (32nds)
225	18211140000	32
235	18211150000	32
245	18211160000	32

- Diamond shaped tread lug design and shoulder notches are optimal for chaining.
- Alternating groove geometry and stone bumper system for maximum stone ejection.
- Aggressive cut and chip resistant compounding to resist the most severe of applications.

TABLES/CHARTS & Tire Information

Medium Truck Load/ Inflation Tables

Safety Warning

Serious Injury May Result From:

- Explosion of tire/rim assembly due to improper mounting. Use safety cage and clip-on extension air hose. Only specially trained persons should mount tires.
- Tire failure due to misapplication/improper inflation/overloading.

Follow tire manufacturer's instructions.

Check inflation pressure frequently with calibrated gauge.

Truck and Bus Tires

Normal and Wide-Base Sizes on 5 Degree or Flat-Based Rims - Radial Ply

Tire Loads Limits at Various Cold Inflation Pressures

24"		kPa	480	520	550	590	620	660	690	720	760	790	830	
		psi	70	75	80	85	90	95	100	105	110	115	120	
325/95R24	*	dual	kg	2780	2860	3020	3140	3250	3350	3450	3550	3650	3760	3875 (J)
			lbs	6120	6390	6650	6910	7160	7390	7610	7830	8050	8300	8540 (J)
	single	kg	2870	3020	3170	3300	3440	3650	3770	3890	4000	4130	4250 (J)	
		lbs	6330	6660	6980	7280	7580	8050	8310	8570	8820	9100	9370 (J)	

Conventional Sizes on 15 Degree Drop-Center Rims - Radial Ply

22.5"		kPa	480	520	550	590	620	660	690	720	760	790	825/830***	
		psi	70	75	80	85	90	95	100	105	110	115	120	
10R22.5	*	dual	kg	1750	1830	1910	2000	2080	2160	2240	2300	2360	2430 (G)	--
			lbs	3860	4045	4230	4410	4585	4760	4940	5075	5210	5355 (G)	--
	single	kg	1850	1940	2030	2120	2200	2280	2360	2430	2500	2575 (G)	--	
		lbs	4080	4280	4480	4675	4850	5025	5205	5360	5515	5675 (G)	--	
11R22.5	*	dual	kg	1990	2080	2160	2250	2360	2460	2560	2650 (G)	2680	2710	2725 (H)
			lbs	4380	4580	4760	4950	5205	5415	5625	5840 (G)	5895	5950	6005 (H)
	single	kg	2050	2160	2260	2370	2500	2600	2700	2800 (G)	2870	2940	3000 (H)	
		lbs	4530	4770	4990	5220	5510	5730	5950	6175 (G)	6320	6465	6610 (H)	
12R22.5	*	dual	kg	2170	2260	2350	2440	2575	2630	2680	2725 (G)	2840	2960	3075 (H)
			lbs	4780	4990	5190	5390	5675	5785	5895	6005 (G)	6265	6525	6780 (H)
	single	kg	2240	2360	2470	2580	2725	2820	2910	3000 (G)	3120	3240	3350 (H)	
		lbs	4940	5200	5450	5690	6005	6205	6405	6610 (G)	6870	7130	7390 (H)	

24.5"		kPa	480	520	550	590	620	660	690	720	760	790	830	
		psi	70	75	80	85	90	95	100	105	110	115	120	
11R24.5	*	dual	kg	2110	2210	2300	2390	2500	2580	2660	2725 (G)	2820	2910	3000 (H)
			lbs	4660	4870	5070	5260	5510	5675	5840	6005 (G)	6205	6405	6610 (H)
	single	kg	2190	2300	2410	2520	2650	2770	2890	3000 (G)	3080	3160	3250 (H)	
		lbs	4820	5070	5310	5550	5840	6095	6350	6610 (G)	6790	6970	7160 (H)	
12R24.5	*	dual	kg	2300	2400	2500	2600	2650	2770	2890	3000 (G)	3080	3160	3250 (H)
			lbs	5080	5300	5520	5730	5840	6095	6350	6610 (G)	6790	6970	7160 (H)
	single	kg	2380	2500	2630	2740	2900	3020	3140	3250 (G)	3350	3450	3550 (H)	
		lbs	5240	5520	5790	6040	6395	6650	6910	7160 (G)	7380	7600	7830 (H)	

* Based on TRA | ** Based On ETRTO

*** Tire & Rim Association has adopted an official equivalency of kPa to psi values. 825 replaces the previous 830.

NOTE: Letters in parentheses denote load range for which boldface loads are maximum.

CAUTION: Always use approved tire and rim combinations for diameters and contours.

NOTE: All values are for 65 mph unless otherwise noted, for tire load and inflation at various speeds, see next pages.

Truck and Bus Tires

Metric and Wide-Base Sizes on 15 Degree Drop-Center Rims - Radial Ply

Tire Loads Limits at Various Cold Inflation Pressures

16"			kPa	240	280	310	340	380	410	450	480	520	550	650		
			psi	35	40	45	50	55	60	65	70	75	80	95		
LT225/75R16	**	Dual	kg	635	675	725	800 (C)	845	885	975 (D)	1000	1040	1120 (E)	1250 (F)		
			lbs	1365	1500	1630	1765 (C)	1875	1995	2150 (D)	2220	2330	2470 (E)	2755 (F)		
		Single	kg	680	745	795	880 (C)	930	970	1060 (D)	1100	1140	1215 (E)	1360 (F)		
			lbs	1500	1650	1790	1940 (C)	2060	2190	2335 (D)	2440	2560	2680 (E)	3000 (F)		
LT235/85R16	**	Dual	kg	720	770	835	910 (C)	960	1025	1080 (D)	1140	1200	1260 (E)	1400 (F)		
			lbs	1545	1700	1845	2006 (C)	2125	2260	2381 (D)	2515	2645	2778 (E)	3085 (F)		
		Single	kg	770	845	920	1000 (C)	1055	1125	1190 (D)	1250	1315	1380 (E)	1550 (F)		
			lbs	1700	1870	2030	2205 (C)	2335	2485	2623 (D)	2765	2905	3042 (E)	3415 (F)		
LT245/75R16	**	Dual	kg	720	770	835	910 (C)	960	1020	1080 (D)	1140	1195	1260 (E)	1400 (F)		
			lbs	1545	1700	1845	2006 (C)	2125	2255	2381 (D)	2515	2640	2778 (E)	3085 (F)		
		Single	kg	770	845	920	1000 (C)	1055	1125	1190 (D)	1250	1315	1380 (E)	1550 (F)		
			lbs	1700	1870	2030	2205 (C)	2335	2480	2623 (D)	2765	2900	3042 (F)	3415 (F)		
17.5"			kPa	480	520	550	590	620	660	690	720	760	790	830	860	
			psi	70	75	80	85	90	95	100	105	110	115	120	125	
215/75R17.5	**	Dual	kg	--	--	1450	1520	1590	1650	1720	1790	1860	1925	1990	2060 (J)	
			lbs	--	--	3195	3500	3500	3645	3795	3945	4095	4245	4390	4545 (J)	
		Single	kg	--	--	1530	1610	1680	1750	1820	1900	1960	2040	2110	2180 (J)	
			lbs	--	--	3375	3540	3695	3860	4010	4180	4330	4495	4650	4805 (J)	
235/75R17.5	**	Dual	kg	--	--	--	--	--	2020	2140	2200	2325	2380	2440	2575 (J)	
			lbs	--	--	--	--	--	4450	4720	4855	5120	5250	5380	5675 (J)	
		Single	kg	--	--	--	--	--	2080	2205	2270	2395	2455	2515	2725 (J)	
			lbs	--	--	--	--	--	4580	4860	5000	5275	5410	5545	6005 (J)	
245/70R17.5	**	Dual	kg	--	--	--	--	--	2020	2140	2200	2325	2380	2440	2575 (J)	
			lbs	--	--	--	--	--	4450	4720	4855	5120	5250	5380	5675 (J)	
		Single	kg	--	--	--	--	--	2080	2205	2270	2395	2455	2515	2725 (J)	
			lbs	--	--	--	--	--	4580	4860	5000	5275	5410	5545	6005 (J)	
19.5"			kPa	480	520	550	590	620	660	690	720	760	790	830	860	900
			psi	70	75	80	85	90	95	100	105	110	115	120	125	130
225/70R19.5	*	Dual	kg	1230	1300	1360	1410	1470	1550	1580	1640	1700 (G)	1750	1800 (H)	1850	1900 (J)
			lbs	2720	2860	3000	3115	3245	3415	3490	3615	3750 (G)	3855	3970 (H)	4085	4190 (J)
		Single	kg	1310	1380	1450	1500	1570	1650	1690	1740	1800 (G)	1860	1900 (H)	1970	2000 (J)
			lbs	2895	3040	3195	3315	3450	3640	3715	3845	3970 (G)	4100	4190 (H)	4245	4410 (J)
245/70R19.5	*	Dual	kg	--	--	1550	1590	1660	1750	1790	1850	1950 (G)	--	--	--	
			lbs	--	--	3415	3515	3655	3860	3940	4075	4410 (G)	--	--	--	
		Single	kg	--	--	1650	1700	1770	1850	1900	1970	2060 (G)	--	--	--	
			lbs	--	--	3640	3740	3890	4080	4190	4335	4540 (G)	--	--	--	
245/70R19.5 (LRH Only)	*	Dual	kg	--	--	1550	1590	1660	1750	1790	1850	1950	1970	2060 (H)	--	
			lbs	--	--	3415	3515	3655	3860	3940	4075	4300	4345	4540 (H)	--	
		Single	kg	--	--	1650	1700	1770	1850	1900	1970	2060	2095	2180 (H)	--	
			lbs	--	--	3640	3740	3890	4080	4190	4335	4540	4620	4805 (H)	--	
265/70R19.5 @81 mph	**	Dual	kg	1560	1640	1700	1780	1860	1950	2000	2000	2120	2360 (H)	--	--	
			lbs	3430	3600	3750	3930	4095	4300	4405	4415	4475	5205 (H)	--	--	
		Single	kg	1660	1740	1800	1900	1970	2060	2130	2200	2300	2500 (H)	--	--	
			lbs	3650	3830	3970	4180	4355	4540	4685	4850	5070	5510 (H)	--	--	
285/70R19.5 LRH @81 mph	**	Dual	kg	--	1870	1970	2065	2160	2260	2355	2450	2540	2630	2725 (H)	--	
			lbs	--	4125	4340	4555	4770	4980	5190	5395	5600	5805	6005 (H)	--	
		Single	kg	--	1990	2100	2200	2305	2405	2505	2605	2705	2805	2900 (H)	--	
			lbs	--	4390	4625	4855	5080	5305	5525	5745	5965	6180	6395 (H)	--	
285/70R19.5 LRJ @ 68 mph	**	Dual	kg	--	--	--	2240	2345	2450	2550	2650	2750	2850	2950	3050	3150 (J)
			lbs	--	--	--	4940	5170	5400	5625	5850	6070	6290	6510	6730	6940 (J)
		Single	kg	--	--	--	2385	2495	2610	2715	2825	2930	3040	3145	3250	3350 (J)
			lbs	--	--	--	5260	5505	5750	5990	6230	6465	6700	6930	7160	7390 (J)
305/70R19.5	*	Dual	kg	--	--	2060	2120	2200	2300	2370	2450	2575	2620	2725	2900 (J)	
			lbs	--	--	4540	4670	4860	5070	5230	5410	5675	5770	6005	6395 (J)	
		Single	kg	--	--	2240	2330	2420	2500	2610	2700	2800	2870	3000	3150 (J)	
			lbs	--	--	4940	5130	5340	5510	5745	5945	6175	6340	6610	6940 (J)	

22.5"			kPa	480	520	550	590	620	660	690	720	760	790	825/830***	860	900
			psi	70	75	80	85	90	95	100	105	110	115	120	125	130
255/70R22.5	*	Dual	kg	--	--	1800	1860	1940	2000	2020	2090	2120	2230	2300 (H)	--	--
			lbs	--	--	3970	4110	4275	4410	4455	4610	4675	4915	5070 (H)	--	--
		Single	kg	--	--	1900	1980	2060	2120	2220	2300	2360	2450	2500 (H)	--	--
			lbs	--	--	4190	4370	4550	4675	4895	5065	5205	5400	5510 (H)	--	--
275/70R22.5	**	Dual	kg	--	--	--	2070	2155	2265	2345	2424	2535	2615	2720	2795	2900 (J)
			lbs	--	--	--	4565	4750	4995	5170	5345	5590	5765	5995	6160	6395 (J)
		Single	kg	--	--	--	2250	2340	2460	2550	2635	2750	2840	2955	3040	3150 (J)
			lbs	--	--	--	4960	5160	5420	5620	5810	6060	6260	6510	6700	6940 (J)
275/80R22.5	**	Dual	kg	1860	1950	2060	2130	2220	2300	2390	2470	2575 (G)	2630	2800 (H)	--	--
			lbs	4095	4300	4540	4690	4885	5070	5260	5440	5675 (G)	5795	6175 (H)	--	--
		Single	kg	2040	2140	2240	2340	2440	2500	2620	2710	2800 (G)	2890	3150 (H)	--	--
			lbs	4500	4725	4940	5155	5370	5510	5780	5980	6175 (G)	6370	6940 (H)	--	--
295/60R22.5 9.00" wheel @ 65mph	**	Dual	kg	-	-	-	2187	2290	2392	2492	2592	2787	2885	2970	3075 (J)	
			lbs	-	-	-	4825	5050	5275	5495	5715	5930	6145	6360	6570	6780 (J)
		Single	kg	-	-	-	2385	2495	2610	2715	2825	2930	3040	3145	3230	3350 (J)
			lbs	-	-	-	5260	5505	5750	5990	6230	6465	6700	6930	7160	7390 (J)
295/60R22.5 9.00" wheel @ 75mph	**	Dual	kg	-	-	-	-	2187	2290	2392	2492	2592	2690	2787	2885	2970 (J)
			lbs	-	-	-	-	4825	5050	5275	5495	5715	5930	6145	6360	6570 (J)
		Single	kg	-	-	-	-	2385	2495	2610	2715	2825	2930	3040	3145	3230 (J)
			lbs	-	-	-	-	5260	5505	5750	5990	6230	6465	6700	6930	7160 (J)
295/75R22.5	*	Dual	kg	1860	1950	2060	2130	2220	2300	2390	2470	2575 (G)	2630	2725 (H)	--	--
			lbs	4095	4300	4540	4690	4885	5070	5260	5440	5675 (G)	5795	6005 (H)	--	--
		Single	kg	2040	2140	2240	2340	2440	2500	2620	2710	2800 (G)	2890	3000 (H)	--	--
			lbs	4500	4725	4940	5155	5370	5510	5780	5980	6175 (G)	6370	6610 (H)	--	--
295/80R22.5	**	Dual	kg	2050	2160	2260	2370	2500	2600	2700	2800	2910	3030	3150 (H)	--	--
			lbs	4530	4770	4990	5220	5510	5730	5950	6175	6415	6670	6945 (H)	--	--
		Single	kg	2380	2500	2630	2740	2900	3020	3140	3250	3350	3450	3550 (H)	--	--
			lbs	5240	5520	5790	6040	6395	6650	6910	7160	7380	7600	7830 (H)	--	--
305/70R22.5	**	Dual	kg	1915	2020	2130	2235	2340	2445	2545	2645	2745	2845	2945	3150 (L)	--
			lbs	4220	4450	4700	4930	5160	5390	5610	5830	6050	6270	6490	6940 (L)	--
		Single	kg	2155	2280	2400	2520	2635	2755	2870	2985	3095	3210	3320	3430	3550 (L)
			lbs	4750	5030	5290	5560	5810	6070	6330	6580	6820	7080	7320	7560	7830 (L)
315/80R22.5	*	Dual	kg	--	--	2575	2650	2750	2900	2970	3070	3150	3270	3450	3600	3750 (L)
			lbs	--	--	5675	5840	6070	6395	6545	6770	6940	7210	7610	7940	8270 (L)
		Single	kg	--	--	2800	2910	3030	3150	3260	3370	3450	3590	3750	3960	4125 (L)
			lbs	--	--	6175	6415	6670	6940	7190	7440	7610	7920	8270	8600	9090 (L)
315/80R22.5** speed restricted LRL		Dual	kg	--	--	2800	2910	3030	3150	3260	3370	3450	3590	3750	3940	4125 (L)
			lbs	--	--	6175	6415	6670	6940	7190	7440	7610	7920	8270	8680	9090 (L)
		Single	kg	--	--	3050	3170	3300	3430	3550	3670	3760	3910	4125	4330	4540 (L)
			lbs	--	--	6725	6990	7275	7560	7825	8090	8290	8620	9090	9545	10000 (L)
385/65R22.5	**	Dual	kg	--	--	--	--	--	--	--	--	--	--	--	--	--
			lbs	--	--	--	--	--	--	--	--	--	--	--	--	--
		Single	kg	2880	3060	3150	3350	3470	3650	3740	3850	4000	4100	4250	4360	4500 (L)
			lbs	6380	6720	6940	7350	7650	8050	8230	8510	8820	9050	9370	9610	9920 (L)
425/65R22.5	**	Dual	kg	--	--	--	--	--	--	--	--	--	--	--	--	--
			lbs	--	--	--	--	--	--	--	--	--	--	--	--	--
		Single	kg	3430	3640	3750	3980	4130	4250	4440	4580	4750	4880	5150 (L)	--	--
			lbs	7590	7990	8270	8740	9100	9370	9790	10100	10500	10700	11400 (L)	--	--
445/50R22.5	*	Dual	kg	--	--	--	--	--	--	--	--	--	--	--	--	--
			lbs	--	--	--	--	--	--	--	--	--	--	--	--	--
		Single	kg	--	3150	3320	3480	3640	3810	3970	4120	4250	4430	4625 (L)	--	--
			lbs	--	6940	7310	7680	8030	8390	8740	9090	9370	9780	10200 (L)	--	--
445/65R22.5	*	Dual	kg	--	--	--	--	--	--	--	--	--	--	--	--	--
			lbs	--	--	--	--	--	--	--	--	--	--	--	--	--
		Single	kg	3720	3950	4125	4320	4470	4625	4820	4960	5150	5290	5600 (L)	--	5800 (M)
			lbs	8230	8660	9090	9480	9870	10200	10600	11000	11400	11700	12300 (L)	--	12800 (M)

24.5"			kPa	480	520	550	590	620	660	690	720	760	790	830
			psi	70	75	80	85	90	95	100	105	110	115	120
285/75R24.5	*	Dual	kg	1870	1970	2060	2150	2240	2360	2410	2490	2575 (G)	2660	2800 (H)
			lbs	4135	4340	4540	4740	4930	5205	5310	5495	5675 (G)	5860	6175 (H)
		Single	kg	2060	2160	2240	2360	2460	2575	2650	2740	2800 (G)	2920	3075 (H)
			lbs	4545	4770	4940	5210	5420	5675	5835	6040	6175 (G)	6440	6780 (H)

* Based on TRA | ** Based On ETRTO

CAUTION: Always use approved tire and rim combinations for diameters and contours.
NOTE: All values are for 65 mph unless otherwise noted, for tire load and inflation at various speeds, see next pages.

*** Tire & Rim Association has adopted an official equivalency of kPa to psi values. 825 replaces the previous 830.

NOTE: Letters in parentheses denote load range for which boldface loads are maximum.

Load Limits At Various Speeds

For Radial Ply Truck Tires Used On Improved Surfaces

(These Tables apply to tires only. Consult rim/wheel manufacturer for rim/wheel load and inflation capacities.)

Tire And Rim Association Standard

FOR METRIC AND WIDE BASE TIRES

The service load and minimum (cold) inflation must comply with the following limitations unless a speed restriction is indicated on the tire or the manufacturer rates the tire at 75 mph or above.

SPEED RANGE (MPH)	RADIAL PLY TIRES	
	INFL. PRESSURE CHANGE	% LOAD CHANGE
71 thru 75	+5 psi	-12%
66 thru 70	+5 psi	-4%
51 thru 65	No Increase	None
41 thru 50	No Increase	+7%
31 thru 40	No Increase	+9%
21 thru 30	+10 psi	+12%
11 thru 20	+15 psi	+17%
6 thru 10	+20 psi	+25%
2.6 thru 5	+20 psi	+45%
Creep thru 2.5	+20 psi	+55%
Creep (2)	+30 psi	+75%
Stationary	+30 psi	+105%

FOR CONVENTIONAL TIRES

The service load and minimum (cold) inflation must comply with the following limitations unless a speed restriction is indicated on the tire or the manufacturer rates the tire at 75 mph or above.

SPEED RANGE (MPH)	RADIAL PLY TIRES	
	INFL. PRESSURE CHANGE	% LOAD CHANGE
71 thru 75	+5 psi	-12%
66 thru 70	+5 psi	-4%
51 thru 65	No Increase	None
41 thru 50	No Increase	+9%
31 thru 40	No Increase	+16%
21 thru 30	+10 psi	+24%
11 thru 20	+15 psi	+32%
6 thru 10 (1)	+30 psi	+60%
2.6 thru 5 (1)	+30 psi	+85%
Creep thru 2.5 (1)	+30 psi	+115%
Creep (1) (2)	+40 psi	+140%
Stationary (1)	+40 psi	+185%

NOTES

1. Apply these increases to Dual Loads and Inflation Pressures.
2. Creep - Motion for not over 200 feet in a 30-minutes period.

Note 1: The inflation pressures shown in the minimum cold pressures for the various loads listed.

Higher pressures should be used as follows:

- A. When required by the above speed/load table.
- B. When higher pressures are desirable to obtain improved operating performance. For speeds above 20 mph, the combined increases of A and B should not exceed 20 psi above the inflation specified for the maximum load of the tire.

Note 2: Load limits at various speed for:
 Tires used in highway service at Restricted Speed.
 Mining and Logging Tires used in Intermittent Highway Service.

THE MAXIMUM LOAD AND INFLATION CAPACITY OF THE RIM MUST NOT BE EXCEEDED.

Load Limits At Various Speeds

Tires Rated At 75 MPH And Radial Ply Truck Tires Used On Improved Surfaces

(These tables apply to tires only. Consult rim/wheel manufacturer for rim/wheel load and inflation capacities.)

Tire And Rim Association Standard

FOR METRIC AND WIDE BASE TIRES		
SPEED RANGE (MPH)	RADIAL PLY TIRES	
	INFL. PRESSURE CHANGE	% LOAD CHANGE
71 thru 75	No Increase	None
66 thru 70	No Increase	None
51 thru 65	No Increase	None
41 thru 50	No Increase	+7%
31 thru 40	No Increase	+9%
21 thru 30	+10 psi	+12%
11 thru 20	+15 psi	+17%
6 thru 10	+20 psi	+25%
2.6 thru 5	+20 psi	+45%
Creep thru 2.5	+20 psi	+55%
Creep (2)	+30 psi	+75%
Stationary	+30 psi	+105%

FOR CONVENTIONAL TIRES		
SPEED RANGE (MPH)	RADIAL PLY TIRES	
	INFL. PRESSURE CHANGE	% LOAD CHANGE
71 thru 75	No Increase	None
66 thru 70	No Increase	None
51 thru 65	No Increase	None
41 thru 50	No Increase	+9%
31 thru 40	No Increase	+16%
21 thru 30	+10 psi	+24%
11 thru 20	+15 psi	+32%
6 thru 10 (1)	+30 psi	+60%
2.6 thru 5 (1)	+30 psi	+85%
Creep thru 2.5 (1)	+30 psi	+115%
Creep (1) (2)	+40 psi	+140%
Stationary (1)	+40 psi	+185%

NOTES

1. Apply these increases to Dual Loads and Inflation Pressures.
2. Creep - Motion for not over 200 feet in a 30-minutes period.

Note 1: The inflation pressures shown in the minimum cold pressures for the various loads listed.

Higher pressures should be used as follows:

- A. When required by the above speed/load table.
- B. When higher pressures are desirable to obtain improved operating performance. For speeds above 20 mph, the combined increases of A and B should not exceed 20 psi above the inflation specified for the maximum load of the tire.

THE MAXIMUM LOAD AND INFLATION CAPACITY OF THE RIM MUST NOT BE EXCEEDED.

Reading Tire Information

Tire Sidewall

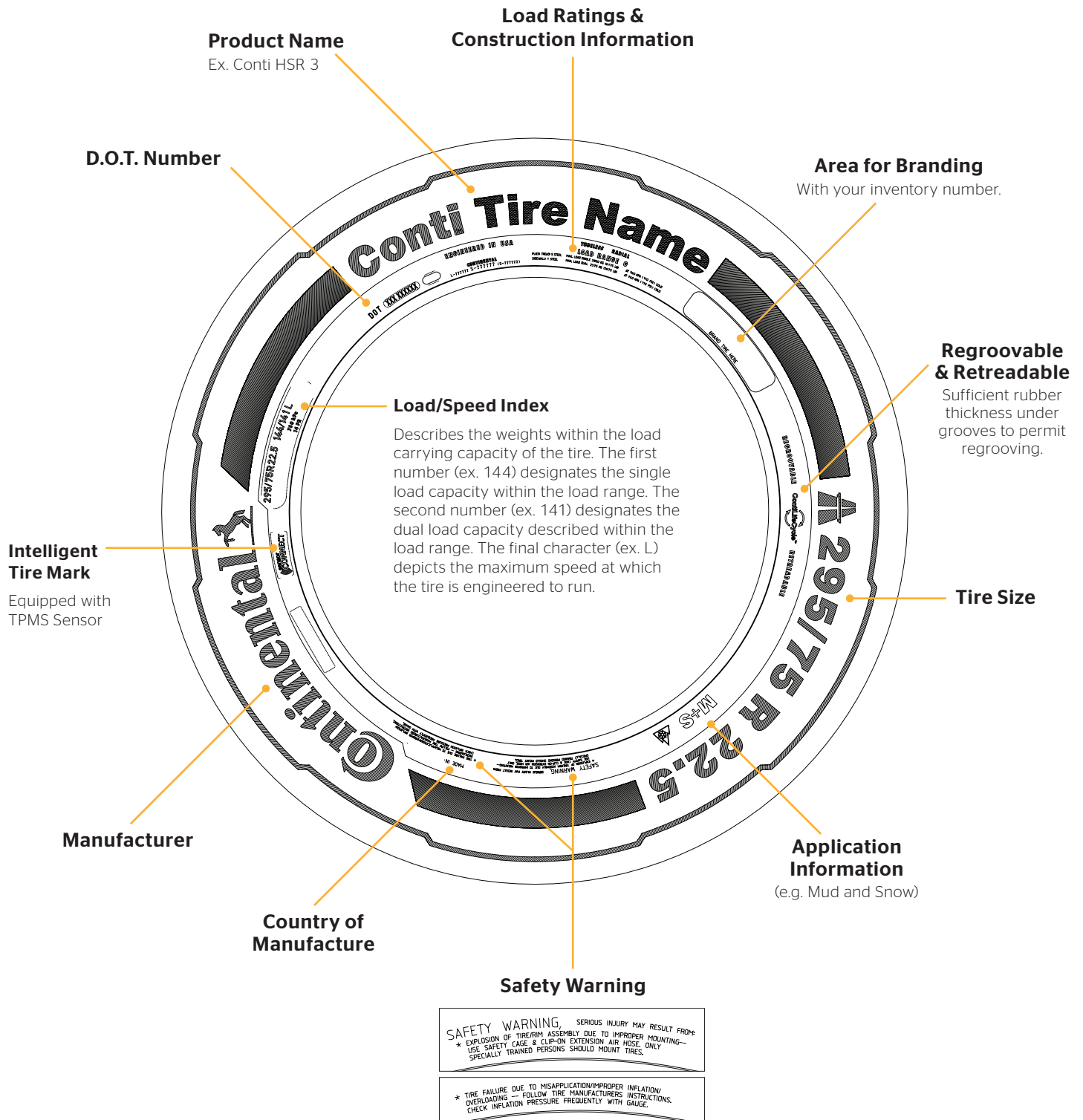

Reading Tire Information

DOT Code

Manufacturing Codes

Characters 1 & 2 = Manufacturer and Plant
Characters 3 & 4 = Tire Size Code
Characters 5/6/7 = Tire Type or Model

New Tire - D.O.T. Number



Department of Transportation

ALL TIRES USED IN U.S.A. MUST DISPLAY A D.O.T. NUMBER.

Date of Manufacturing

Characters 1 & 2 = Week of Manufacture (01 - 53)
Characters 3 & 4 = Year of Manufacture (Last 2 Digits)

Retreaded Tire - D.O.T. Number

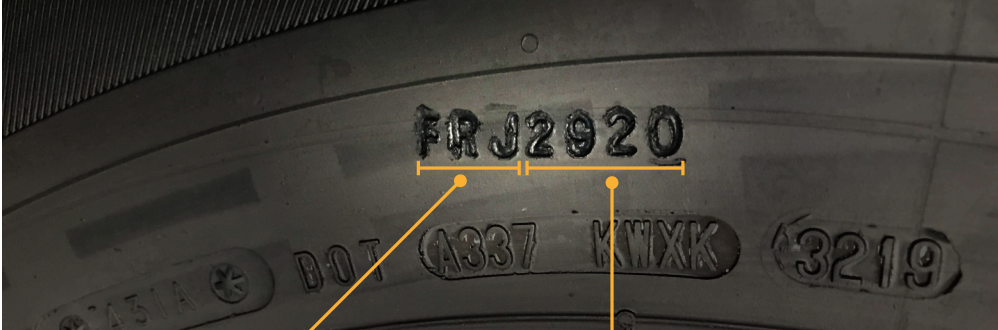

Manufacturing Retread Facility

Characters 1 - 3 = Retread Facility

Date of Manufacturing

Characters 4 & 5 = Week of Manufacture (01 - 53)
Characters 6 & 7 = Year of Manufacture (Last 2 Digits)

Reading Tire Information

New Generation Product Naming

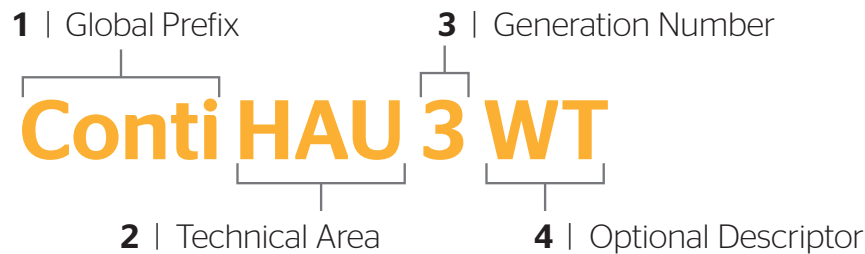

Step 1 Global Prefix

Moving forward, every new tire will begin with Conti (or ContiTread for retread), regardless of segment, region, or application. This universal prefix will help unify our diverse product line.

Step 2 Technical Area

This area provides essential information to help ensure the right tire goes on the right vehicle.

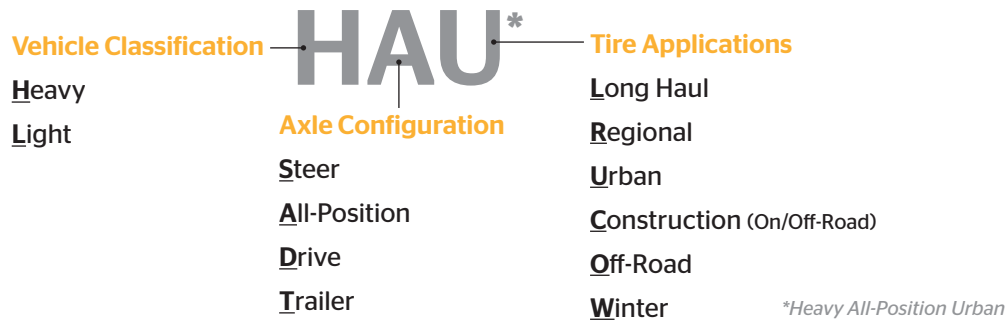

Step 3 Generation Number (1st, 2nd, 3rd, etc.)

Step 4 Optional Descriptor

Although it may be left blank, this space covers additional information about a tire's specialized characteristics to help our customers find the optimal tire.

EP Eco Plus | **DL** Deep Lug | **WT** Waste Transport | **& more...**

PLEASE NOTE: If these two characters are included, they are part of the tire name and essential to its identification. For example, a **Conti HSL 3** and a **Conti HSL 3 EP** could both exist, and would be two entirely different tires with different tread patterns, article numbers, and benefits.



Example 1: Conti HSL 3

Heavy Vehicle / Steer Axle / Long Haul Application (3rd Generation)



Example 2: Conti HSR 3

Heavy Vehicle / Steer Axle / Regional Application (3rd Generation)

Definitions

New Tire Dimensions

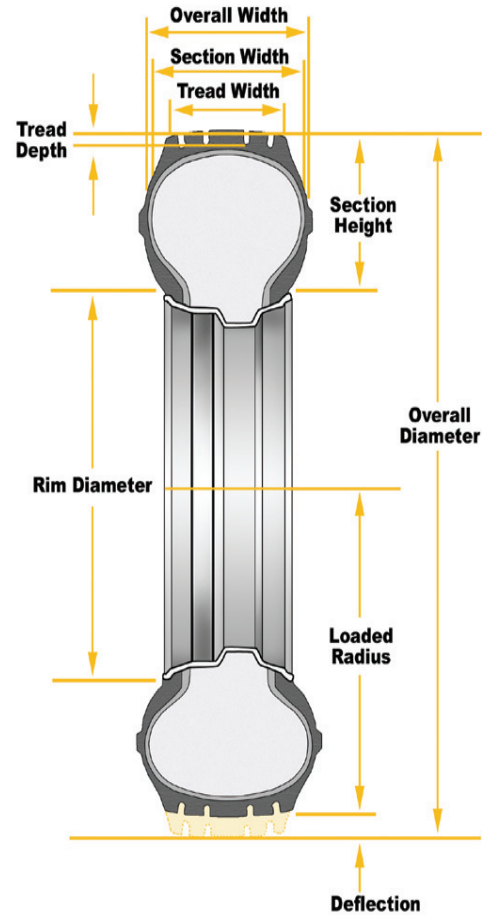
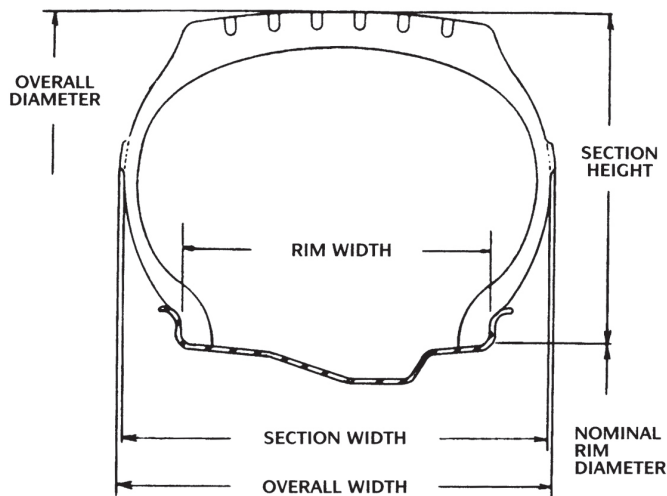

Aspect Ratio	Section Height Section Width
Rim Width	Linear distance between the flanges of the rim.
Static Loaded Radius	Distance from wheel axle centerline to supporting tread surface at a given load and pressure in a static condition.
Tire (Overall) Width	The width of a new tire, including 24-hour inflation growth, and including protective side ribs, bars and decorations.
Section Height	Half the difference between the overall diameter and the nominal rim diameter.
Overall Diameter	The diameter of an inflated tire at the outermost surface of the tread, including 24-hour inflation growth.
Revolutions Per Mile	Measured number of revolutions for a tire traveling one mile. This can vary with speed, load, and inflation.
Tread Width	Distance across tread from shoulder to shoulder.
Width Loaded	Tire width (overall) under rated load conditions.
Minimum Dual Spacing	Minimum dual tire centerline to centerline measurement.
Section Width	Linear distance between outside of sidewalls of inflated tire (exclusive of markings, etc.).

Low Aspect Ratio Tires

24.5 Inch Highway Size

(USING TYPICAL DESIGN DIMENSIONS)

Match Tire For Speed And Axle Weights

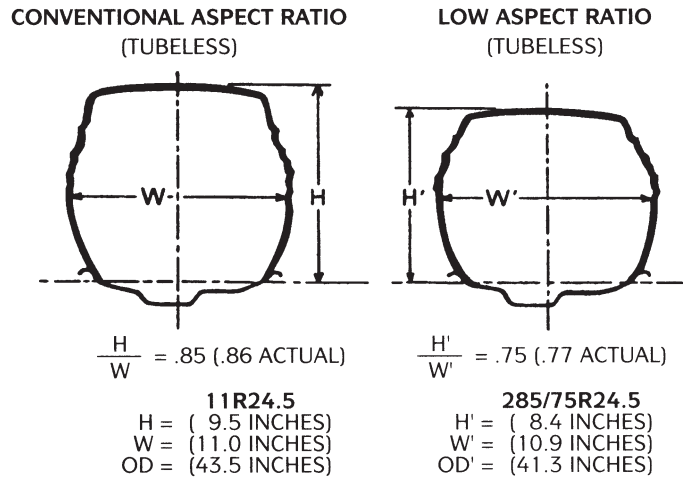

In a tire selection process, it is mandatory that consideration be given to selecting a tire size and load range which at least equals the maximum load requirements by axle position (steer, drive or trail). All highway truck tires have load limits established for tires used in normal highway service. Therefore, when selecting a tire for service, both the carrying capacity and speed implications must be considered.

TIRE LOAD LIMITS AT VARIOUS COLD INFLATION PRESSURES										
THE PRESSURE IS MINIMUM FOR LOAD										
MAXIMUM SPEED OF 65 (MPH)						Example for LRG				
SIZE			70 (480)	75 (520)	80 (550)	85 (590)	90 (620)	95 (660)	100 (690)	105 (720)
11R22.5	Dual	kg	1990	2080	2160	2250	2360	2460	2560	2650 (G)
		lbs	4380	4580	4760	4950	5205	5415	5625	5840 (G)
	Single	kg	2050	2160	2260	2370	2500	2600	2700	2800 (G)
		lbs	4530	4770	4990	5220	5510	5730	5950	6175 (G)
11R24.5	Dual	kg	2110	2210	2300	2390	2500	2580	2660	2725 (G)
		lbs	4660	4870	5070	5260	5510	5675	5840	6005 (G)
	Single	kg	2190	2300	2410	2520	2650	2770	2890	3000 (G)
		lbs	4820	5070	5310	5550	5840	6095	6350	6610 (G)

For example, when selecting tires for a tractor and trailer combination with a gross combination weight (GCW) of 80,000 lbs. and an axle weight distribution of 12,000 lbs. on the steer, 34,000 lbs. on the tandem drive and 34,000 lbs. on the tandem trailer axles, the most common conventional tire sizes used are 11R22.5 Load Range G and 11R24.5 Load Range G. The load and inflation schedule according to the Tire and Rim Association tables for these sizes is shown above.

Service Descriptions

Continental Tire the Americas, LLC provides a service description onto the sidewall of all premium products.

This service description, which consists of one or more load indices and speed symbols, is located close to the tire size designation on the sidewall of the tire.

The load index relates to the maximum load carrying capacities allowed at the speed indicated by the speed symbol.

The speed symbol relates to the maximum speed allowed for the load carrying capacities associated with the load index.

The following is an example of a load index / speed symbol associated with a medium radial truck tire:

144/141



Load Indices
(Single/Dual)

L



Speed Symbol

The attached chart shows the comparison of load index to load and speed symbol to maximum speed for radial truck tire products.

Consult your local Continental Tire representative for confirmation of the suitability of the tire/wheel assembly for the intended service.

Truck-Bus Metric Tires

International Load Index Numbers

LOAD INDEX	Kg	Lbs.
119	1360	3000
120	1400	3085
121	1450	3195
122	1500	3305
123	1550	3415
124	1600	3525
125	1650	3640
126	1700	3750
127	1750	3860
128	1800	3970
129	1850	4080
130	1900	4190
131	1950	4300
132	2000	4410
133	2060	4540
134	2120	4675
135	2180	4805
136	2240	4940
137	2300	5070
138	2360	5205
139	2430	5355
140	2500	5510
141	2575	5675
142	2650	5840
143	2725	6005
144	2800	6175

LOAD INDEX	Kg	Lbs.
145	2900	6395
146	3000	6610
147	3075	6780
148	3150	6940
149	3250	7160
150	3350	7390
151	3450	7610
152	3550	7830
153	2650	8050
154	3750	8270
155	3875	8540
156	4000	8820
157	4125	9090
158	4250	9370
159	4375	9650
160	4500	9920
161	4625	10200
162	4750	10500
163	4875	10700
164	5000	11000
165	5150	11400
166	5300	11700
167	5450	12000
168	5600	12300
169	5800	12800
170	6000	13200

SPEED SYMBOL	SPEED (kmh)	SPEED (mph)
F	80	50
G	90	56
J	100	62
K	110	68
L	120	75
M	130	81
N	140	87
P	150	93
Q	160	99
R	170	106
S	180	112
T	190	118

LOAD RANGE	PLY RATING
A	2
B	4
C	6
D	8
E	10
F	12
G	14
H	16
J	18
L	20
M	22
N	24

Truck Tire Tread Depth Conversion Table to Percent Of Wear:

Original Tire Tread Depths in 32nds

Tread Remaining	32nd	12	13	14	15	16	17	18	19	20	21	22	23	24	25	26	27	28	29	30	32	37	38	39	40	41	32nd	Tread Remaining	
	2/32	100%	100%	100%	100%	100%	100%	100%	100%	100%	100%	100%	100%	100%	100%	100%	100%	100%	100%	100%	100%	100%	100%	100%	100%	100%	2/32		
	3/32	90	91	92	92	93	93	94	94	94	95	95	95	95	96	96	96	96	96	96	97	97	97	97	97	97	97	3/32	
	4/32	80	82	83	85	86	87	88	88	89	89	90	90	91	91	92	92	92	93	93	93	94	94	94	95	95	95	4/32	
	5/32	70	73	75	77	79	80	81	82	83	84	85	86	86	87	88	88	88	89	89	90	91	92	92	92	92	92	5/32	
	6/32	60	64	67	69	71	73	75	76	78	79	80	81	82	83	83	84	85	85	86	87	89	89	89	89	89	90	6/32	
	7/32	50	55	58	62	64	67	69	71	72	74	75	76	77	78	79	80	81	81	82	83	86	86	86	86	87	87	7/32	
	8/32	40	45	50	54	57	60	63	65	67	68	70	71	73	74	75	76	77	78	79	80	83	83	84	84	85	8/32		
	9/32	30	36	42	46	50	53	56	59	61	63	65	67	68	70	71	72	73	74	75	77	80	81	81	82	82	9/32		
	10/32	20	27	33	38	43	47	50	53	56	58	60	62	64	65	67	68	69	70	71	73	77	78	78	79	79	10/32		
	11/32	10	18	25	31	36	40	44	47	50	53	55	57	59	61	63	64	65	67	68	70	74	75	76	76	77	11/32		
	12/32	0	9	17	23	29	33	38	41	44	47	50	52	54	57	58	60	62	63	64	67	71	72	73	74	74	12/32		
	13/32		0	8	15	21	27	33	35	39	42	45	45	50	52	54	56	58	59	61	63	69	69	70	71	72	13/32		
	14/32			0	8	14	20	25	29	33	37	40	43	45	48	50	52	54	56	57	60	66	67	68	68	69	14/32		
	15/32				0	7	13	19	24	28	32	35	38	41	43	46	48	50	52	54	57	63	64	65	66	67	15/32		
	16/32					0	6	13	18	22	26	30	33	36	39	42	44	46	48	50	53	60	61	62	63	64	16/32		
	17/32						0	6	12	17	21	25	29	32	35	38	40	42	44	46	50	57	58	59	61	62	17/32		
	18/32							0	6	11	16	20	24	27	30	33	36	39	41	43	47	54	56	57	58	59	18/32		
	19/32								0	6	11	15	19	23	26	29	32	35	37	39	43	51	53	54	55	56	19/32		
	20/32									0	5	10	14	18	22	25	28	31	33	36	40	49	50	51	53	54	20/32		
	21/32										0	5	10	14	17	21	24	27	30	32	37	46	47	49	50	51	21/32		
	22/32											0	5	5	13	17	20	23	26	29	33	43	44	46	47	49	22/32		
	23/32												0	9	9	13	16	19	22	25	30	40	42	43	45	46	23/32		
	24/32													0	4	8	12	15	19	21	27	37	39	41	42	44	24/32		
	25/32														0	4	8	12	15	18	23	34	36	38	39	41	25/32		
	26/32															0	4	8	11	14	21	31	33	35	37	38	26/32		
	27/32																0	4	7	11	17	29	31	32	34	36	27/32		
	28/32																	0	4	7	13	26	28	30	32	33	28/32		
	29/32																		0	4	10	23	25	27	29	31	29/32		
	30/32																				0	7	20	22	24	26	28	30/32	
	31/32																					3	17	19	22	24	26	31/32	
	32/32																					0	14	17	19	21	23	32/32	
	33/32																						11	14	16	18	21	33/32	
	34/32																						9	11	14	16	18	34/32	
	35/32																						6	8	11	13	15	35/32	
	36/32																						3	6	8	11	13	36/32	
	37/32																						0	3	5	8	10	37/32	
	38/32																							0	3	5	8	38/32	
	39/32																								0	3	5	39/32	
	40/32																									0	3	40/32	
	41/32																										0	41/32	

SAFETY WARNING

SERIOUS INJURY MAY RESULT FROM:

Explosion of tire/rim assembly due to improper mounting - use safety cage and clip on extension air hose. Only specially trained persons should mount tires.

Tire failure due to misapplication/improper inflation/overloading - follow tire manufacturer's instructions. Check inflation pressure frequently with gauge.

A tire must always match the diameter requirements of the rim to which it is being mounted. For example, a 16 inch tire must always be mounted on a 16 inch rim. Also, when replacing the truck type radial tires, use only wheels approved for radial tires.

Retread Casing Fitment Guide

Tread Width Followed By Tire Sizes

150	185 (continued)	205 (continued)	215 (continued)	225 (continued)	245 (continued)	390
9R22.5	245/70R19.5	225/70R19.5	225/70R19.5	12.00R24	12.00R24	445/50R22.5
215/85R16	265/70R19.5	225/75R16	245/70R19.5	11R24.5	11R22.5	455/55R22.5
160	255/70R22.5	235/75R17.5	265/70R19.5	12R24.5	11R24.5	400
215/85R16	10R17.5	235/85R16	285/70R19.5	230	250	445/50R22.5
225/75R16	9R22.5	245/70R17.5	255/70R22.5	275/80R22.5	365/80R20	455/55R22.5
235/85R16	10R22.5	245/70R19.5	275/70R22.5	295/75R22.5	305/70R22.5	410
215/75R17.5	195	245/75R16	275/80R22.5	285/75R24.5	315/80R22.5	445/50R22.5
235/75R17.5	215/85R16	255/70R22.5	295/75R22.5	11R22.5	12.00R24	455/55R22.5
10R17.5	225/75R16	265/70R19.5	285/75R24.5	12R22.5	260	
9R22.5	235/85R16	275/70R22.5	10R22.5	12.00R24	315/80R22.5	
170	245/75R16	275/80R22.5	11R22.5	11R24.5	305/75R24.5	
215/85R16	215/75R17.5	285/70R19.5	12R22.5	12R24.5	270	
225/75R16	235/75R17.5	285/75R24.5	12.00R24	235	315/80R22.5	
235/85R16	225/70R19.5	295/75R22.5	11R24.5	275/80R22.5	305/75R24.5	
215/75R17.5	245/70R19.5	245/75R22.5	12R24.5	295/75R22.5	280	
235/75R17.5	265/70R19.5	265/75R22.5	220	285/75R24.5	315/80R22.5	
225/70R19.5	255/70R22.5	210	235/75R17.5	11R22.5	290	
10R17.5	10R17.5	225/75R16	245/70R17.5	12R22.5	365/80R20	
9R22.5	9R22.5	235/85R16	245/70R19.5	12.00R24	385/65R22.5	
10R22.5	10R22.5	245/75R16	265/70R19.5	11R24.5	320	
180	200	235/75R17.5	285/70R19.5	12R24.5	365/80R20	
215/85R16	225/75R16	245/70R17.5	255/70R22.5	240	385/65R22.5	
225/75R16	235/85R16	225/70R19.5	275/70R22.5	275/80R22.5	425/65R22.5	
235/85R16	245/75R16	245/70R19.5	275/80R22.5	295/75R22.5	340	
245/75R16	215/75R17.5	265/70R19.5	295/75R22.5	295/80R22.5	18R19.5	
215/75R17.5	235/75R17.5	285/70R19.5	295/80R22.5	305/70R22.5	18R22.5	
235/75R17.5	245/70R17.5	255/70R22.5	285/75R24.5	315/80R22.5	445/65R22.5	
225/70R19.5	225/70R19.5	275/70R22.5	10R22.5	285/75R24.5	445/65R19.5	
245/70R19.5	245/70R19.5	275/80R22.5	11R22.5	11R22.5	445/50R22.5	
255/70R22.5	265/70R19.5	295/75R22.5	12R22.5	12R22.5	425/65R22.5	
10R17.5	255/70R22.5	285/75R24.5	12.00R24	12.00R24	350	
9R22.5	10R17.5	10R22.5	11R24.5	11R24.5	18R19.5	
10R22.5	10R22.5	11R22.5	12R24.5	12R24.5	18R22.5	
185	12.00R24	12R22.5	225	245	445/65R22.5	
215/85R16	205	12.00R24	285/70R19.5	295/75R22.5	445/65R19.5	
225/75R16	10R22.5	11R24.5	275/80R22.5	275/80R22.5	445/50R22.5	
235/85R16	11R22.5	12R24.5	295/75R22.5	285/75R24.5	425/65R22.5	
245/75R16	11R24.5	215	295/80R22.5	295/80R22.5	360	
215/75R17.5	12.00R24	235/85R16	285/75R24.5	365/80R20	445/65R22.5	
235/75R17.5	12R22.5	235/75R17.5	11R22.5	305/70R22.5	380	
225/70R19.5	12R24.5	245/70R17.5	12R22.5	315/80R22.5	445/65R22.5	

***Not a technical recommendation or guide.** For use as sales information only. Please consult your local authorized ContiLifeCycle dealer for technical specifications.

Safety Warnings

Tire Demounting And Mounting Safety Precautions



SAFETY WARNING

SERIOUS INJURY OR DEATH MAY RESULT FROM:

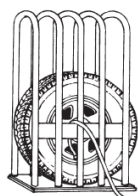

EXPLOSION OF TIRE RIM ASSEMBLY DUE TO IMPROPER MOUNTING - USE SAFETY CAGE & CLIP-ON EXTENSION AIR HOSE. ONLY SPECIALLY TRAINED PERSONS SHOULD MOUNT TIRES.



WARNING

Tire and wheel servicing can be dangerous, and should be done by trained personnel using proper tool and procedures and safety precautions in the RMA's "Demounting and Mounting Procedures for Trucks/Bus Tires" and "Inspection procedures for identification of potential zipper ruptures in steel cord radial medium and light truck tires" charts and service bulletins.

Failure to comply with these procedures may result in faulty positioning of the tire and/or rim parts, and cause the assembly to burst with explosive force, sufficient to cause serious injury or death. Never mount or use damaged tires or rims.

MISAPPLICATION/IMPROPER INFLATION/OVERLOADING SAFETY WARNINGS



WARNING

There is danger of serious injury or death if a tire of one bead diameter is installed on a rim or wheel of a different rim diameter.

Re-assembly and inflation of mismatched parts can result in serious injury or death. Just because parts come in together does not mean they belong together. Check for proper matching of all rim parts before putting any parts together.

Always replace a tire of exactly the same bead diameter designation and suffix letters.

For example: A 16" tire goes on a 16" rim. Never mount a 16" tire on a 16.1" or 16.5" rim. A 16.1" tire goes on a 16.1" Never mount a 16.1" tire on a 16" or 16.5" rim. A 16.5" tire goes on 16.5" rim. Never mount a 16.5" tire on a 16" or 16.1" rim.

While it is possible to pass a 16" diameter tire over the lip or flange of a 16.1" or 16.5" size diameter rim, it cannot be inflated enough to position itself against the rim flange. If an attempt is made to seat the tire bead by inflating, the tire bead will break with explosive force and could cause serious injury or death.

Rims of different diameters and tapers cannot be interchanged. The following diagram illustrates the difference between rims of two different tapers and diameters.

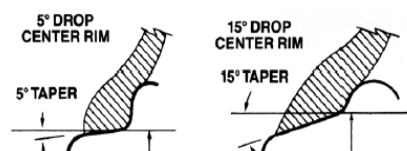

The following diagram shows how beads of a 16" tire will not seat on a 16.5" rim. The beads cannot be forced out against the rim flanges by using more air pressure because this will break the beads and the tire will explode with force sufficient to cause serious injury or death.



Never assemble a tire and rim unless you have positively identified and correctly matched the parts.

Safety Warnings

Tire Demounting And Mounting Safety Precautions

⚠ WARNING

NEVER inflate beyond 40 pounds pressure to seat beads.

NEVER stand, lean or reach over the assembly during inflation.

Inspect both sides of the tire to be sure that the beads are evenly seated. If tire is mounted on a machine that does not have a positive lock-down device to hold the wheel, inflation should be done on a safety cage. If both beads are not properly seated when pressure reaches 40 pounds air pressure, completely deflate the assembly, reposition the tire and/or tube on the rim, re-lubricate and reinflate. Inflating beyond 40 pounds air pressure when trying to seat the beads is a DANGEROUS PRACTICE that may break a tire bead (or even the rim) with explosive force, possibly resulting in serious injury or death. After the beads are fully seated, pressure may be increased above 40 psi to operating pressures, not to exceed the maximum labeled on the tire sidewall.

⚠ WARNING

Permanent tire damage due to under inflation and/or overloading cannot always be detected. Any tire known or suspected to have been run at 80% or less of normal operating inflation pressure and/or overloaded, could possibly have permanent structural damage (steel cord fatigue). Ply cords weakened by under inflation and/or overloading may break one after another, until a rupture occurs in the upper sidewall with accompanying instantaneous air loss and explosive force. This can result in serious injury or death.

Any tire of having been operated and under inflated and/or overloaded must be approached with caution. Completely deflate the tire by removing the valve core before removing the tire/rim/wheel assembly from the vehicle. After removing from the vehicle, clearly identify the tire so it will not be reinflated **until carefully inspected by a trained technician** to determine the cause of under inflation, as well as any tire damage resulting from under inflation and/or overloading.

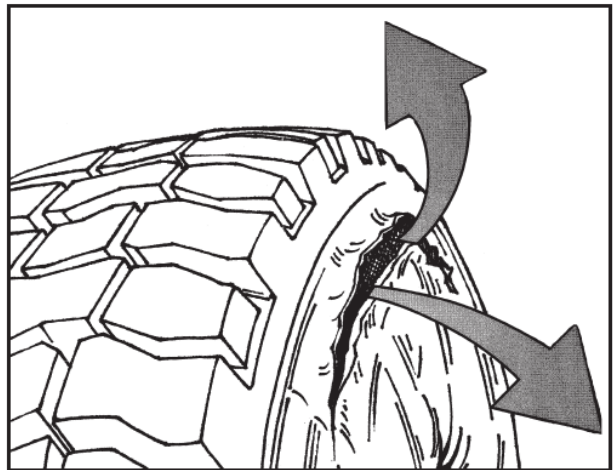

⚠ WARNING

The use of any flammable material during tire servicing is absolutely prohibited. Use of starting fluid ether, gasoline, or any other flammable material to lubricate, seal or seat the beads of a tubeless tire can cause the tire to explode or can cause the explosive separation of the tire/rim assembly resulting in serious injury or death.

This practice may also result in undetected damage to the tire or rim that could result in failure of the tire in service.

Safety Warnings

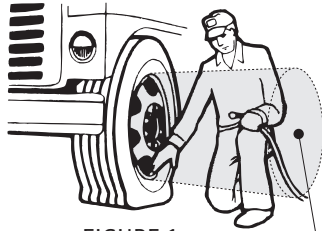

FIGURE 1

STAY OUT OF THE TRAJECTORY AS INDICATED BY SHADED AREA

Note: Under some circumstances, the trajectory may deviate from its expected path.

Always deflate tires before handling. Inflate only in safety cage.



FIGURE 2

TRAJECTORY

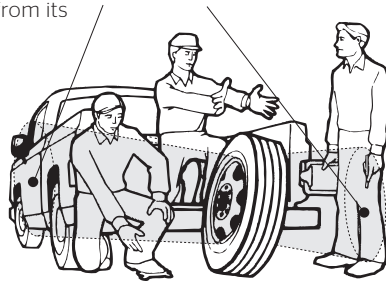

FIGURE 3

The air pressure contained in a tire is dangerous. The sudden release of this pressure by a tire blow-out or side ring separation can cause serious injury or death. Stay out of the trajectory as indicated by shaded area. When installing the tire/rim assembly on the vehicle, it will be impossible to stay out of the trajectory; however, at all other time you and all others must stay out of the trajectory.

⚠ WARNING

Tire explosions can cause death or personal injury or property damage.

Excessive speed in a free-running, unloaded tire can cause it to “explode” from extreme centrifugal force.

⚠ WARNING

When mounting dual disc wheels on a vehicle, be sure to carefully check and retighten or re-torque inner cap nuts before mounting the outer wheel. In demounting the outer wheel, there is a possibility that the inner cap nuts may have been loosened accidentally.

NEVER rework, weld, heat, or braze the tire/wheel/rim. Heating the rim of tire/wheel/rim. Heating the rim of tire/wheel/rim assembly can cause a tire to explode, causing serious injury or death,

NEVER hammer, strike or pry any type of tire/rim assembly while the tire contains inflation pressure. Do not attempt to seat any part while the tire contains any inflation pressure. This could result in serious injury.

Regrooving

Continental, General Tire, AmeriSteel, and Euzkadi brand truck tires that have “REGROOVABLE” molded on the sidewall may be regrooved. After regrooving, it is required that 3/32” of under tread remains to cover the top ply. It is the responsibility of the regroover to assure that all Federal Regulations are met. For further clarification, see Code of Federal Regulations: Title 49, Transportation; Parts 569 and 393.75.



Continental Tire the Americas, LLC
1830 MacMillan Park Drive
Fort Mill, SC 29707
Phone: 704-583-3900

Technical Customer Services & Warranty
3000 Continental Parkway
Clinton, MS 39056
Phone: 800-726-7113
TI_CQ_SM_help.trucktires@continental.com

Original Equipment Sales
800-776-2022

Commercial Specialty Tires
877-235-0102

INSIDE SALES / U.S.
800-450-4028 East
800-450-3187 West

